

8 7 6 5 4 3 2 1

D

D

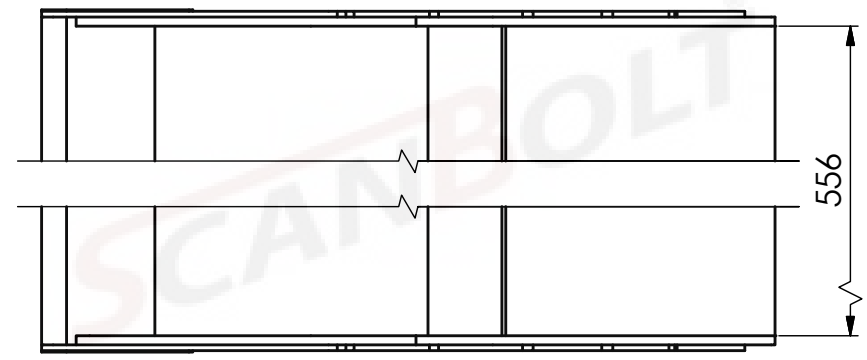
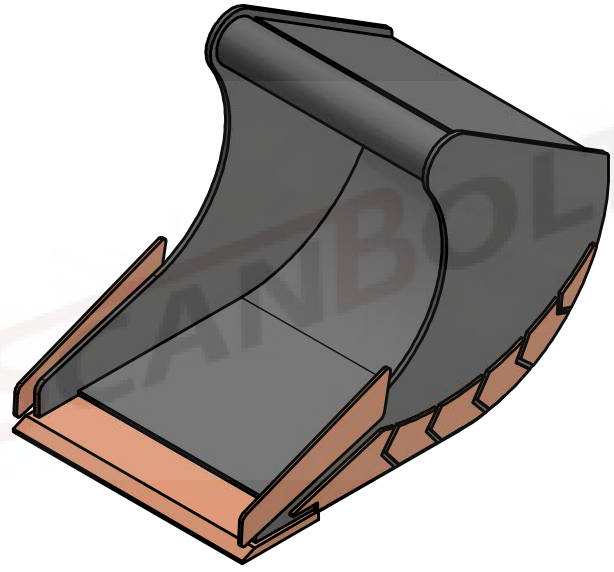

C

C

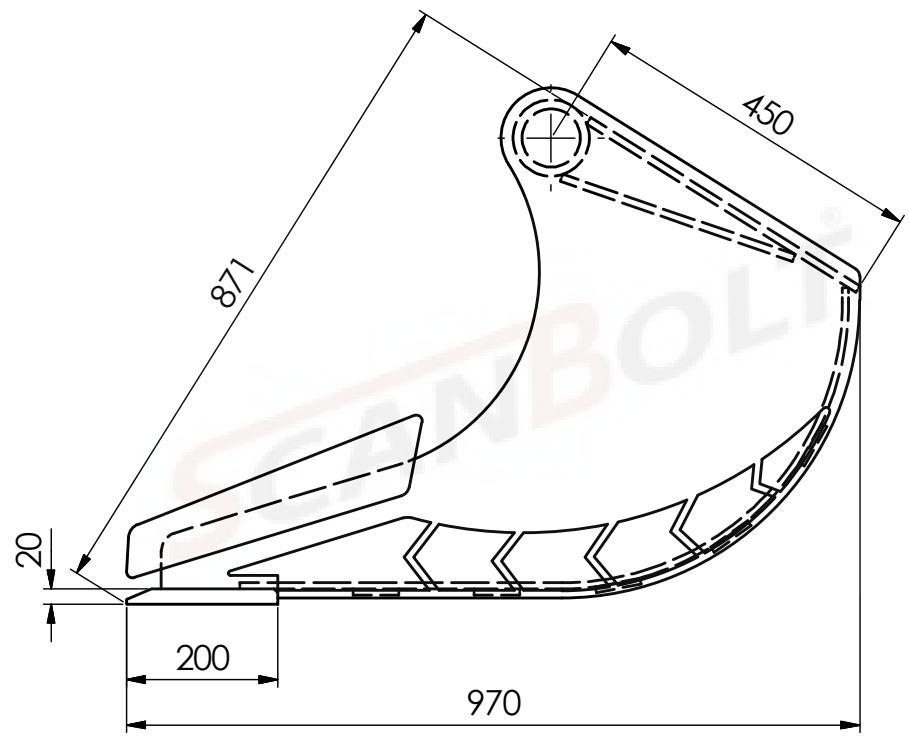
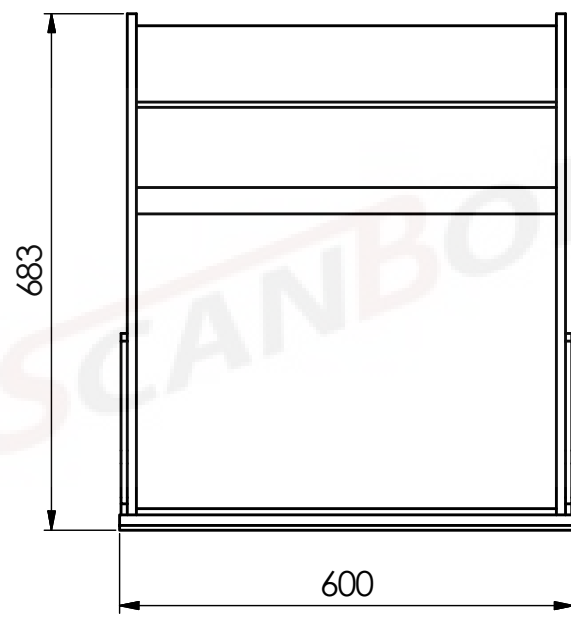





B

B

A

A

MATERIAL SPECIFICATION	
	ST52.3
	EN8D
	HB 400
	HB 450
	CASTALLOY STEEL

SCANBOLT®	
DESCRIPTION	60CM DIGGING BUCKET
MACHINE CLASS	7.5-10 TON
WEIGHT	183.8 Kg
HEAPED CAPACITY	231.4 LITERS

8 7 6 5 4 3 2 1